

2012



JHT

WWW.JHTCL.COM





JINHENG TONG

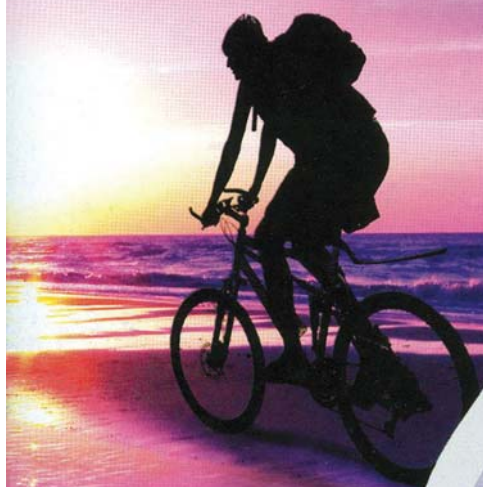

CONTENTS

- ▶ 1-9 ALLOY CARRIER
- ▶ 10-15 STEEL CARRIER FOR EUROPEAN MARKET
- ▶ 16-19 STEEL CARRIER FOR JAPANESE MARKET
- ▶ 20 STEEL BASKET FOR JAPANESE MARKET
- ▶ 21-25 DOUBLE STAND

BRIEF INTRODUCTION

China & Foreign jointventure Tangshan JinHengTong Bicycle Parts Co., Ltd was established in 1997, and mainly manages the producing and selling of the bicycle parts. It is one of the largest bicycle parts producing factories in China, it occupies about one hundred thousand square meters, and now its staffs are more than one thousand.

Since the foundation of the company, we have enforced the “Honest, surefooted, steady” as our enterprise spirit and diligent working attitude. We have built a bicycle parts kingdom of producing bicycle rim, carrier and stand. We emphasize Quality Management and have built two laboratories with complete testing equipment and advanced testing means, of which one is for chemical test, another is for physical test. We own a talented team with the advanced management experience for the technology exploration, jobsite management, goods examination and good sale, the first-class production and fabrication equipment and an advanced-technology team for development and exploration of appropriate equipment of the bicycle.

Its title that “Honest and Credit will make the cause prosperous, quality will enhance the reputation” wins a high reputation at the same industry in China.

Personnel of JinHengTong is ready to serve you with its zest of hardworking, confidence, responsibility, one hundred percent of satisfaction is our aim and obligation.

The JinHengTongs will make unremitting efforts and pursuit to win more development together with you.

-  26-28 STEEL KICKSTAND
-  29 ALLOY KICKSTAND
-  30-35 ALLOY DOUBLE WALL RIM
-  36-37 SECTION OF ALLOY RIM
-  38 STEEL RIM
-  39-40 OTHER PARTS

ALLOY CARRIER



 **HLYJ-A4**
MATERIAL; AL
BIKE SIZE; 20" 24" 26"
SURFACE TREATMENT; POWDER COATING



 **HLYJ-D1**
MATERIAL; AL
BIKE SIZE; 24" 26" 700C
SURFACE TREATMENT; POWDER COATING
ANODIZED SILVER



 **HLYJ-D2**
MATERIAL; AL
BIKE SIZE; 24" 26" 28"
SURFACE TREATMENT; POWDER COATING
ANODIZED SILVER



 **HLYJ-D3**
MATERIAL; AL
BIKE SIZE; 24" 26" 28"
SURFACE TREATMENT; POWDER COATING
ANODIZED SILVER



 **HLYJ-D3-2**
MATERIAL; AL
BIKE SIZE; 24" 26" 28"
SURFACE TREATMENT; POWDER COATING
ANODIZED SILVER



 **HLYJ-D6**
MATERIAL; AL
BIKE SIZE; 24" 26" 28"
SURFACE TREATMENT; POWDER COATING
ANODIZED SILVER



ALLOY CARRIER



HLYJ-D7

MATERIAL: AL

BIKE SIZE: 24" 26" 28"

SURFACE TREATMENT: POWDER COATING
ANODIZED SILVER



HLYJ-D8

MATERIAL: AL

BIKE SIZE: 24" 26" 28"

SURFACE TREATMENT: POWDER COATING
ANODIZED SILVER



HLYJ-D8A

MATERIAL: AL

BIKE SIZE: 24" 26" 28"

SURFACE TREATMENT: POWDER COATING
ANODIZED SILVER



HLYJ-D9

MATERIAL: AL

BIKE SIZE: 24" 26" 28"

SURFACE TREATMENT: POWDER COATING
ANODIZED SILVER



HLYJ-D10

MATERIAL: AL

BIKE SIZE: 24" 26" 28"

SURFACE TREATMENT: POWDER COATING
ANODIZED SILVER



HLYJ-D11

MATERIAL: AL

BIKE SIZE: 24" 26" 28"

SURFACE TREATMENT: POWDER COATING
ANODIZED SILVER

HJHT



ALLOY CARRIER



HLYJ-D12

MATERIAL: AL
BIKE SIZE: 24" 26" 28"
SURFACE TREATMENT: POWDER COATING
ANODIZED SILVER



HLYJ-D14

MATERIAL: AL
BIKE SIZE: 24" 26" 28"
SURFACE TREATMENT: POWDER COATING
ANODIZED SILVER



HLYJ-E2

MATERIAL: AL
BIKE SIZE: 24" 26" 28"
SURFACE TREATMENT: POWDER COATING
ANODIZED SILVER



HLYJ-E2-1

MATERIAL: AL
BIKE SIZE: 24" 26" 28"
SURFACE TREATMENT: POWDER COATING
ANODIZED SILVER



HLYJ-E3

MATERIAL: AL
BIKE SIZE: 24" 26" 28"
SURFACE TREATMENT: POWDER COATING
ANODIZED SILVER



HLYJ-E4

MATERIAL: AL
BIKE SIZE: 24" 26" 28"
SURFACE TREATMENT: POWDER COATING
ANODIZED SILVER



8

ALLOY CARRIER



HLYJ-E5

MATERIAL: AL
BIKE SIZE: 24" 26" 28"
SURFACE TREATMENT: POWDER COATING
 ANODIZED SILVER



HLYJ-E6

MATERIAL: AL
BIKE SIZE: 24" 26" 28"
SURFACE TREATMENT: POWDER COATING
 ANODIZED SILVER



HLYJ-E15

MATERIAL: AL
BIKE SIZE: 24" 26" 28"
SURFACE TREATMENT: POWDER COATING
 ANODIZED SILVER



HLYJ-E19-1

DESCRIPTION: Alloy rear carrier
BIKE SIZE: Adjustable 24"-28"
FINISH: Anod coloring (gray, bronze, imitating stainless color)
 Anod shiny silver
 P/C silver or black



HLYJ-F1

MATERIAL: AL
BIKE SIZE: 24" 26" 28"
SURFACE TREATMENT: POWDER COATING
 ANODIZED SILVER



HLYJ-G1

MATERIAL: AL
BIKE SIZE: 24" 26" 28"
SURFACE TREATMENT: POWDER COATING
 ANODIZED SILVER

ALLOY CARRIER



HLYJ-G2

MATERIAL: AL

BIKE SIZE: 24" 26" 28"

SURFACE TREATMENT: POWDER COATING



HLYJ-G5

MATERIAL: AL

BIKE SIZE: 24" 26" 28"

SURFACE TREATMENT: POWDER COATING
ANODIZED SILVER



HLYJ-H7

MATERIAL: AL

BIKE SIZE: 24" 26" 28"

SURFACE TREATMENT: POWDER COATING
ANODIZED SILVER



HLYJ-H11

MATERIAL: AL

BIKE SIZE: 24" 26" 28"

SURFACE TREATMENT: POWDER COATING
ANODIZED SILVER



HLYJ-J1-3

MATERIAL: AL

BIKE SIZE: 24" 26" 28"

SURFACE TREATMENT: POWDER COATING
ANODIZED SILVER



HLYJ-J1-3A

MATERIAL: AL

BIKE SIZE: 20" 24" 26"

SURFACE TREATMENT: POWDER COATING
ANODIZED SILVER

ALLOY CARRIER



HLYJ-J2

MATERIAL: AL
BIKE SIZE: 24" 26" 28"
SURFACE TREATMENT: POWDER COATING
 ANODIZED SILVER



HLYJ-J2A-1

MATERIAL: AL
BIKE SIZE: 24" 26" 28"
SURFACE TREATMENT: POWDER COATING
 ANODIZED SILVER



HLYJ-J1-4

DESCRIPTION: Alloy rear carrier
BIKE SIZE: 24" 26" 28"
FINISH: Anod coloring
 (gray, bronze, imitating stainless color)
 Anod shiny silver
 P/C silver or black



HLYJ-J1-5

DESCRIPTION: Alloy front carrier
BIKE SIZE: 24" 26" 28"
FINISH: Anod coloring
 (gray, bronze, imitating stainless color)
 Anod shiny silver
 P/C silver or black



HLYJ-J4

MATERIAL: AL
BIKE SIZE: 24" 26" 28"
SURFACE TREATMENT: POWDER COATING
 ANODIZED SILVER



HLYJ-J5

MATERIAL: AL
BIKE SIZE: 20" 22" 24"
SURFACE TREATMENT: POWDER COATING
 ANODIZED SILVER

ALLOY CARRIER



HLYJ-J6
 MATERIAL: AL
 BIKE SIZE: 24" 26" 28"
 SURFACE TREATMENT: POWDER COATING
 ANODIZED SILVER



HLYJ-J8
 MATERIAL: AL
 BIKE SIZE: 24" 26" 28"
 SURFACE TREATMENT: POWDER COATING
 ANODIZED SILVER



HLYJ-L2
 MATERIAL: AL
 BIKE SIZE: 24" 26" 28"
 SURFACE TREATMENT: POWDER COATING
 ANODIZED SILVER



HLYJ-L5
 DESCRIPTION: Alloy rear carrier
 BIKE SIZE: 24" 26" 28"
 FINISH: Anod coloring
 (gray, bronze, imitating stainless color)
 Anod shiny silver P/C silver or black



HLYJ-L6
 MATERIAL: AL
 BIKE SIZE: 24" 26" 28"
 SURFACE TREATMENT: POWDER COATING
 ANODIZED SILVER



HLYJ-10G
 MATERIAL: AL
 BIKE SIZE: 24" 26" 28"
 SURFACE TREATMENT: POWDER COATING
 ANODIZED SILVER



ALLOY CARRIER



HLYJ-Q1

MATERIAL: AL

BIKE SIZE: 16" 18" 20"

SURFACE TREATMENT: POWDER COATING



HLYJ-Q2-1

MATERIAL: AL

BIKE SIZE: 24" 26" 28"

SURFACE TREATMENT: POWDER COATING



HLYJ-Q2

MATERIAL: AL

BIKE SIZE: 24" 26" 28"

SURFACE TREATMENT: POWDER COATING

HJHT



ALLOY CARRIER



HLYJ-Y1

DESCRIPTION: Alloy rear carrier
BIKE SIZE: 24" 26" 28"
FINISH: Anod coloring
 (gray, bronze, imitating stainless color)
 Anod shiny silver
 P/C silver or black



HLYJ-Y10

DESCRIPTION: Alloy rear carrier
BIKE SIZE: 24" 26" 28"
FINISH: Anod coloring
 (gray, bronze, imitating stainless color)
 Anod shiny silver
 P/C silver or black



HLYJ-Z1

MATERIAL: AL
BIKE SIZE: 24" 26" 28"
SURFACE TREATMENT: POWDER COATING
 ANODIZED SILVER



HLYJ-25

MATERIAL: AL
BIKE SIZE: 24" 26" 28"
SURFACE TREATMENT: POWDER COATING
 ANODIZED SILVER



STEEL CARRIER FOR EUROPEAN MARKET



HYJ-01
 MATERIAL: STEEL
 BIKE SIZE: 24" 26" 28"
 SURFACE TREATMENT: ED/POWDER COATING



HYJ-01A-6
 MATERIAL: STEEL
 BIKE SIZE: 24" 26" 28"
 SURFACE TREATMENT: POWDER COATING



HYJ-01H
 MATERIAL: STEEL
 BIKE SIZE: 24" 26" 28"
 SURFACE TREATMENT: ED/POWDER COATING



HYJ-02-1
 MATERIAL: STEEL
 BIKE SIZE: 18" 20" 24"
 SURFACE TREATMENT: ED/POWDER COATING



HYJ-02C-1
 MATERIAL: STEEL
 BIKE SIZE: 20" 24" 26"
 SURFACE TREATMENT: ED/POWDER COATING



HYJ-07B-1
 MATERIAL: STEEL
 BIKE SIZE: 20" 24" 26" 700C
 SURFACE TREATMENT: ED/POWDER COATING

STEEL CARRIER FOR EUROPEAN MARKET



HYJ-07C
 MATERIAL; STEEL
 BIKE SIZE; 20" 24" 26" 700C
 SURFACE TREATMENT; CP ED POWDER COATING



HYJ-9BS
 MATERIAL; STEEL
 BIKE SIZE; 24" 26" 28"
 SURFACE TREATMENT; ED/POWDER COATING



HYJ-10F
 MATERIAL; STEEL
 BIKE SIZE; 24" 26" 28"
 SURFACE TREATMENT; ED/POWDER COATING



HYJ-10G
 MATERIAL; STEEL
 BIKE SIZE; 24" 26"
 SURFACE TREATMENT; POWDER COATING



HYJ-10G-1
 MATERIAL; STEEL
 BIKE SIZE; 20" 24" 26"
 SURFACE TREATMENT; ED/POWDER COATING



HYJ-10G-2A
 MATERIAL; STEEL
 BIKE SIZE; 24" 26" 28"
 SURFACE TREATMENT; POWDER COATING



STEEL CARRIER FOR EUROPEAN MARKET



HGYJ-10H
MATERIAL: STEEL
BIKE SIZE: 24" 26" 28"
SURFACE TREATMENT: ED/POWDER COATING



HGYJ-10K
MATERIAL: STEEL
BIKE SIZE: 24" 26" 28"
SURFACE TREATMENT: POWDER COATING



HGYJ-10M
MATERIAL: STEEL
BIKE SIZE: 24" 26" 28"
SURFACE TREATMENT: POWDER COATING



HYJ-11B
MATERIAL: STEEL
BIKE SIZE: 24" 26"
SURFACE TREATMENT: ED



HGYJ-11C-1
MATERIAL: STEEL
BIKE SIZE: 24" 26" 28"
SURFACE TREATMENT: POWDER COATING



HGYJ-11G
MATERIAL: STEEL
BIKE SIZE: 24" 26" 28"
SURFACE TREATMENT: POWDER COATING

STEEL CARRIER FOR EUROPEAN MARKET

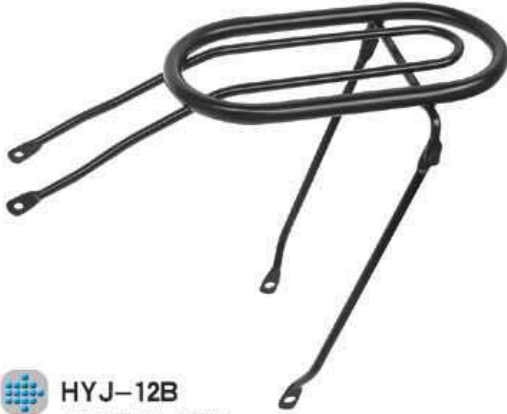

HYJ-12B
 MATERIAL: STEEL
 BIKE SIZE: 18" 20"
 SURFACE TREATMENT: POWDER COATING



HYJ-12I
 MATERIAL: STEEL
 BIKE SIZE: 24" 26"
 SURFACE TREATMENT: ED/POWDER COATING



HYJ-15A
 MATERIAL: STEEL
 BIKE SIZE: 20" 22" 24"
 SURFACE TREATMENT: ED/POWDER COATING



HYJ-15A-2
 MATERIAL: STEEL
 BIKE SIZE: 24" 26" 28"
 SURFACE TREATMENT: ED/POWDER COATING



HYJ-15A-2K
 MATERIAL: STEEL
 BIKE SIZE: 24" 26" 28"
 SURFACE TREATMENT: ED/POWDER COATING

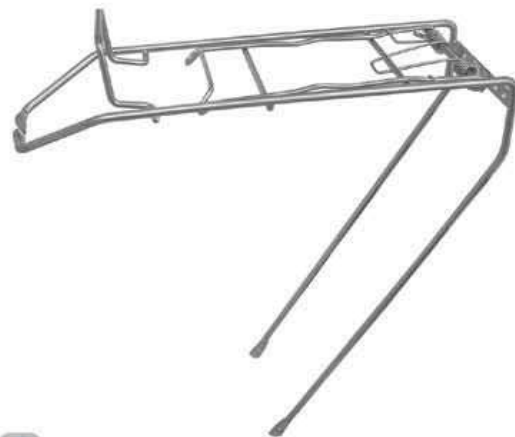

HYJ-15B
 MATERIAL: STEEL
 BIKE SIZE: 24" 26" 28"
 SURFACE TREATMENT: ED/POWDER COATING

STEEL CARRIER FOR EUROPEAN MARKET



HYJ-15C
 MATERIAL; STEEL
 BIKE SIZE; 20" 22" 24" 26" 28"
 SURFACE TREATMENT;
 ED/POWDER COATING



HYJ-15C-1
 MATERIAL; STEEL
 BIKE SIZE; 20" 24" 26"
 SURFACE TREATMENT;
 ED/POWDER COATING

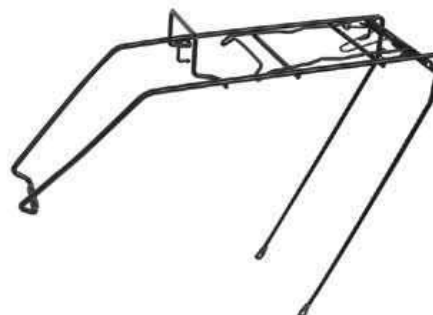

HYJ-15D
 MATERIAL; STEEL
 BIKE SIZE; 24" 26" 28"
 SURFACE TREATMENT;
 ED/POWDER COATING



HYJ-15K
 MATERIAL; STEEL
 BIKE SIZE; 24" 26" 28"
 SURFACE TREATMENT;
 ED/POWDER COATING



HYJ-15Z
 MATERIAL; STEEL
 BIKE SIZE; 24" 26" 28"
 SURFACE TREATMENT;
 ED/POWDER COATING



HYJ-20
 MATERIAL; STEEL
 BIKE SIZE; 24" 26" 28"
 SURFACE TREATMENT;
 ED/POWDER COATING



HYJ-20A
 MATERIAL; STEEL
 BIKE SIZE; 24" 26" 28"
 SURFACE TREATMENT;
 ED/POWDER COATING



HYJ-21
 MATERIAL; STEEL
 BIKE SIZE; 26" 28"
 SURFACE TREATMENT;
 ED/POWDER COATING



HYJ-29
 MATERIAL; STEEL
 BIKE SIZE; 24" 26" 28"
 SURFACE TREATMENT;
 ED/POWDER COATING

STEEL CARRIER FOR EUROPEAN MARKET



HGYJ-01A-5
 MATERIAL: STEEL
 BIKE SIZE: 24" 26" 27"
 SURFACE TREATMENT: POWDER COATING



HGYJ-20A
 MATERIAL: STEEL
 BIKE SIZE: 24" 26" 28"
 SURFACE TREATMENT: POWDER COATING



HGYJ-28
 MATERIAL: STEEL
 BIKE SIZE: 20" 24" 26"
 SURFACE TREATMENT: POWDER COATING



HGYJ-31
 MATERIAL: STEEL
 BIKE SIZE: 26" 28"
 SURFACE TREATMENT: EP/POWDER COATING



HZYJ-01
 MATERIAL: STEEL
 BIKE SIZE: 24" 26"
 SURFACE TREATMENT: POWDER COATING

STEEL CARRIER FOR JAPANESE MARKET



HYJ-02C
 MATERIAL: STEEL
 BIKE SIZE: 24" 26"
 SURFACE TREATMENT: CP ED SF



HYJ-03A
 MATERIAL: STEEL
 BIKE SIZE: 24" 26"
 SURFACE TREATMENT: CP ED SF



HYJ-04A
 MATERIAL: STAINLESS / STEEL
 BIKE SIZE: 24" 26" 27"
 SURFACE TREATMENT: POLISH / CP ED SF



HYJ-04A-1A
 MATERIAL: STAINLESS / STEEL
 BIKE SIZE: 24" 26" 27"
 SURFACE TREATMENT: POLISH / CP ED SF



HYJ-04A-3
 MATERIAL: STAINLESS / STEEL
 BIKE SIZE: 24" 26" 27"
 SURFACE TREATMENT: POLISH / CP ED SF



HYJ-04B
 MATERIAL: STAINLESS / STEEL
 BIKE SIZE: 24" 26" 27"
 SURFACE TREATMENT: POLISH / CP ED SF

STEEL CARRIER FOR JAPANESE MARKET



HYJ-04B-1

MATERIAL: STAINLESS / STEEL
BIKE SIZE: 24" 26" 27"
SURFACE TREATMENT: POLISH / CP ED SF



HYJ-04B-2

MATERIAL: STAINLESS / STEEL
BIKE SIZE: 22" 24" 26" 27"
SURFACE TREATMENT: POLISH / CP ED SF



HYJ-04B-3

MATERIAL: STAINLESS / STEEL
BIKE SIZE: 22" 24" 26" 27"
SURFACE TREATMENT: POLISH / CP ED SF



HYJ-04B-3F

MATERIAL: STAINLESS / STEEL
BIKE SIZE: 22" 24" 26" 27"
SURFACE TREATMENT: POLISH / CP ED SF



HYJ-04B-4

MATERIAL: STAINLESS / STEEL
BIKE SIZE: 24" 26" 27"
SURFACE TREATMENT: POLISH / CP ED SF



HYJ-04B-7

MATERIAL: STAINLESS / STEEL
BIKE SIZE: 24" 26" 27"
SURFACE TREATMENT: POLISH / CP ED SF

STEEL CARRIER FOR JAPANESE MARKET



HYJ-04E
 MATERIAL: STEEL
 BIKE SIZE: 24" 26" 27"
 SURFACE TREATMENT: POLISH / CP ED SF



HYJ-04C
 MATERIAL: STAINLESS / STEEL
 BIKE SIZE: 24" 26" 27"
 SURFACE TREATMENT: POLISH / CP ED SF



HYJ-05
 MATERIAL: STEEL
 BIKE SIZE: 24" 26" 27"
 SURFACE TREATMENT: POLISH / CP ED SF



HYJ-06
 MATERIAL: STEEL
 BIKE SIZE: 24" 26" 27"
 SURFACE TREATMENT: CP SF



HYJ-06-1
 MATERIAL: STEEL
 BIKE SIZE: 24" 26" 27"
 SURFACE TREATMENT: CP SF



HYJ-10B
 MATERIAL: STEEL
 BIKE SIZE: 24" 26"
 SURFACE TREATMENT: POWDER COATING

STEEL CARRIER FOR JAPANESE MARKET



HGYJ-10E
MATERIAL: STAINLESS / STEEL
BIKE SIZE: 24" 26" 27"
SURFACE TREATMENT: POLISH / CP ED SF



HYJ-15H
MATERIAL: STAINLESS / STEEL
BIKE SIZE: 22" 24" 26" 27"
SURFACE TREATMENT: POLISH / CP ED SF



HGYJ-22
MATERIAL: STAINLESS / STEEL
BIKE SIZE: 22" 24" 26" 27"
SURFACE TREATMENT: POLISH

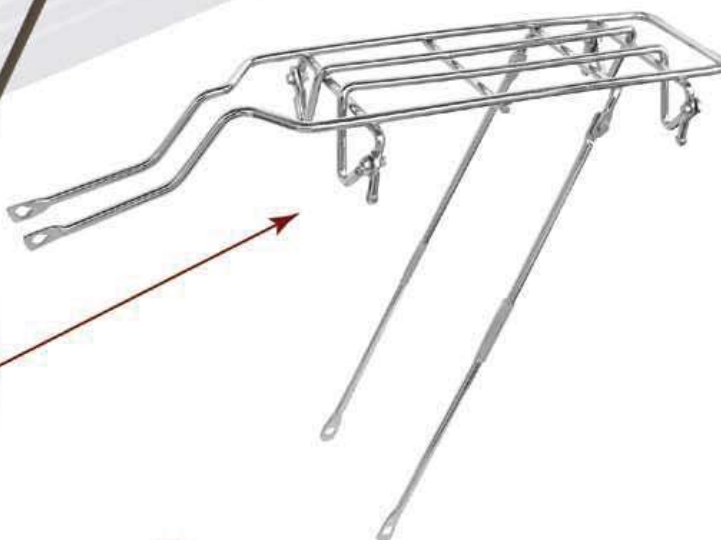

HYJ-27A
MATERIAL: STAINLESS / STEEL
BIKE SIZE: 24" 26" 27"
SURFACE TREATMENT: POLISH / CP ED SF



STEEL BASKET FOR JAPANESE MARKET



HQK-01

MATERIAL: STEEL
SURFACE TREATMENT: CP ED



HCK-01

MATERIAL: STEEL
SURFACE TREATMENT: CP ED

HJHT[®]



DOUBLE STAND



 **HZJ-01**
MATERIAL: STAINLESS / STEEL
BIKE SIZE: 24" 26" 27"
SURFACE TREATMENT: POLISH / CP ED SF



 **HZJ-01-1**
MATERIAL: STEEL
BIKE SIZE: 16" 18" 20"
SURFACE TREATMENT: CP ED



 **HZJ-01A-A**
MATERIAL: STEEL
BIKE SIZE: 24" 26" 700C
SURFACE TREATMENT: CP



 **HZJ-01B (AUTO LOCK)**
FOR ELECTRIC BICYCLE
MATERIAL: STEEL
BIKE SIZE: 22" 24"
SURFACE TREATMENT: CP

DOUBLE STAND



 **HZJ-01C**
MATERIAL: STEEL
BIKE SIZE: 20" 22" 24" 26"
SURFACE TREATMENT: CP



 **HZJ-01F(AUTO LOCK)**
MATERIAL: STEEL
BIKE SIZE: 20" 24" 26" 27"
SURFACE TREATMENT: CP ED



 **HZJ-01G**
MATERIAL: STAINLESS/STEEL
BIKE SIZE: 20" 24" 26" 27"
SURFACE TREATMENT: POLISH / CP ED SF



 **HZJ-01H**
MATERIAL: STEEL
BIKE SIZE: 24" 26" 27"
SURFACE TREATMENT: CP ED

DOUBLE STAND



 **HZJ-01K**
MATERIAL: STEEL
BIKE SIZE: 24" 26"
SURFACE TREATMENT: CP ED



 **HZJ-01L (AUTO LOCK)**
MATERIAL: STEEL
BIKE SIZE: 24" 26" 27"
SURFACE TREATMENT: CP ED



 **HZJ-01M (AUTO LOCK)**
MATERIAL: STEEL
BIKE SIZE: 24" 26"
SURFACE TREATMENT: CP ED



 **HZJ-01T-1 (AUTO LOCK)**
MATERIAL: STEEL
BIKE SIZE: 24" 26"
SURFACE TREATMENT: CP ED

DOUBLE STAND



HZJ-01Y FOR AXLE DRIVING BIKE

MATERIAL: STEEL

BIKE SIZE: 24" 26" 27"

SURFACE TREATMENT: CP ED



JIN HENG TONG

HJHT



DOUBLE STAND



 **HDZJ-01H**
MATERIAL: STEEL
BIKE SIZE: 16"-24"
SURFACE TREATMENT: CP ED



 **HDZJ-01N-2**
MATERIAL: STEEL
BIKE SIZE: 14"-24"
SURFACE TREATMENT: CP ED



 **HDZJ-01N-3A(AUTO LOCK)**
MATERIAL: STEEL
BIKE SIZE: 14"-24"
SURFACE TREATMENT: CP ED



 **HDZJ-01N-4(AUTO LOCK)**
MATERIAL: STEEL
BIKE SIZE: 14"-24"
SURFACE TREATMENT: CP ED

STEEL KICKSTAND

PATENT



HZJ-12

MATERIAL: STEEL
BIKE SIZE: 24" 26" 28"
SURFACE TREATMENT: CP ED

PATENT



HZJ-14A

MATERIAL: STEEL
BIKE SIZE: 24" 26" 28"
SURFACE TREATMENT: CP ED

PATENT



HZJ-13

MATERIAL: STEEL
BIKE SIZE: 14" 16" 18" 20"
SURFACE TREATMENT: CP ED

PATENT



HZJ-12A

MATERIAL: STEEL
BIKE SIZE: 14" 16" 18" 20"
SURFACE TREATMENT: CP ED

PUSH

HJHT

26

STEEL KICKSTAND



HZJ-02
 MATERIAL: STEEL
 BIKE SIZE: 22" 24" 26" 27"
 SURFACE TREATMENT: CP ED



HZJ-02A
 MATERIAL: STEEL
 BIKE SIZE: 14" 16" 18" 20"
 SURFACE TREATMENT: CP ED



HZJ-03
 MATERIAL: STEEL
 BIKE SIZE: 24" 26" 27"
 SURFACE TREATMENT: CP ED SF



HZJ-03A
 MATERIAL: STEEL
 BIKE SIZE: 22" 24" 26" 27"
 SURFACE TREATMENT:
 CP ED SF



HZJ-03B
 MATERIAL: STEEL
 BIKE SIZE: 24" 26" 28"
 SURFACE TREATMENT:
 CP ED SF



HZJ-03C
 MATERIAL: STEEL
 BIKE SIZE: 22" 24" 26" 27"
 SURFACE TREATMENT:
 CP ED SF



HZJ-04B
 MATERIAL: STEEL
 BIKE SIZE: 24" 26" 28"
 SURFACE TREATMENT:
 CP SF



HZJ-05
 MATERIAL: STEEL
 BIKE SIZE: 22" 24" 26" 27"
 SURFACE TREATMENT: CP ED ED



HZJ-05-1
 MATERIAL: STEEL
 BIKE SIZE: 24" 26" 28"
 SURFACE TREATMENT: CP SF



HZJ-05B
 MATERIAL: STEEL
 BIKE SIZE: 22" 24" 26" 27"
 SURFACE TREATMENT: CP ED

STEEL KICKSTAND



HZJ-05B-1
 MATERIAL: STEEL
 BIKE SIZE: 22" 24" 26" 27" 700C
 SURFACE TREATMENT: CP ED



HZJ-05E
 MATERIAL: STEEL
 BIKE SIZE: 24" 26" 27"
 SURFACE TREATMENT: CP ED



HZJ-06
 MATERIAL: STEEL
 BIKE SIZE: 24" 26" 700C
 SURFACE TREATMENT: CP ED



HZJ-06A
 MATERIAL: STEEL
 BIKE SIZE: 24" 26" 27" 28"
 SURFACE TREATMENT:
 ED/POWDER COATING



HZJ-07
 MATERIAL: STEEL
 BIKE SIZE: 16" 18" 20" 24" 26"
 SURFACE TREATMENT: CP ED



HZJ-07A
 MATERIAL: STEEL
 BIKE SIZE: 14" 16" 18" 20"
 SURFACE TREATMENT: CP ED



HZJ-07B-1
 MATERIAL: STEEL
 BIKE SIZE: 14" 16" 18" 20"
 SURFACE TREATMENT: CP ED



HZJ-07C
 MATERIAL: STEEL
 BIKE SIZE: 14" 16" 18" 20"
 SURFACE TREATMENT: CP SF



HZJ-08
 MATERIAL: STEEL
 BIKE SIZE: 24" 26" 27"
 SURFACE TREATMENT: CP ED SF

ALLOY KICKSTAND



HLZJ-06

DESCRIPTION:

ALLOY CENTER KICKSTAND

BIKE SIZE: 24" 26" 28"

FINISH: POLISH/ANOD SILVER



Adjustable:
24"-28"



HLZJ-06-3

DESCRIPTION:

ALLOY CENTER KICKSTAND

BIKE SIZE: ADJUSTABLE 24"-28"

FINISH: POLISH/ANOD SILVER



HLZJ-06A-1

DESCRIPTION:

ALLOY REAR KICKSTAND

BIKE SIZE: 24"26"28"

FINISH: PC BLACK/ANOD SILVER



Adjustable
24"-28"



HLZJ-06A-2

DESCRIPTION:

ALLOY REAR KICKSTAND

BIKE SIZE: ADJUSTABLE 24"-28"

FINISH: PC BLACK



Adjustable
24"-28"



HLZJ-06C

DESCRIPTION:

ALLOY CENTER KICKSTAND

BIKE SIZE: ADJUSTABLE 24"-28"

FINISH: PC BLACK



HLZJ-06D-2

DESCRIPTION:

ALLOY CENTER KICKSTAND

BIKE SIZE: 24"26"28"

FINISH: ANOD SILVER

ALLOY DOUBLE WALL RIM



HLQC-01

SIZE: 700C

- 27" × 1-3/8
- 26" × 1-3/8
- 26" × 1.5-1.75
- 24" × 1.5-1.75
- 20" × 1.5-1.75

JOINT: PINNED

FINISH: POWDER WITH CNC ANODIZED

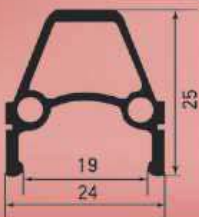
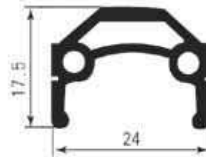

HLQC-02A

SIZE: 700C

- 26" × 1.5-1.75
- 24" × 1.5-1.75
- 20" × 1.5-1.75

JOINT: PINNED

FINISH: POWDER WITH CNC ANODIZED



HLQC-02AB

SIZE: 700C

- 26" × 1.5-1.75
- 24" × 1.5-1.75
- 20" × 1.5-1.75

JOINT: PINNED

FINISH: POWDER WITH CNC ANODIZED

HJHT®



ALLOY DOUBLE WALL RIM



HLQC-02AD

SIZE: 700C

26" × 1.5-1.75

24" × 1.5-1.75

20" × 1.5-1.75

16" × 1.5-1.75

JOINT: PINNED

FINISH: POWDER WITH CNC
ANODIZED



HLQC-02D

SIZE: 700C

26" × 1.5-1.75

24" × 1.5-1.75

20" × 1.5-1.75

JOINT: PINNED

FINISH: POWDER WITH CNC
ANODIZED



HLQC-04

SIZE: 700C

26" × 1.5-1.75

24" × 1.5-1.75

JOINT: PINNED

FINISH: POWDER WITH CNC ANODIZED



HLQC-04B-1

SIZE: 700C

27" × 1-3/8

26" × 1.5-1.75

24" × 1.5-1.75

JOINT: PINNED

FINISH: POWDER WITH CNC
ANODIZED

ALLOY DOUBLE WALL RIM

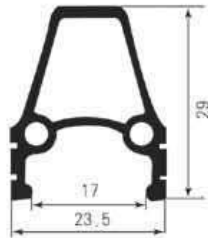

HLQC-04B

SIZE: 27" × 1-3/8"

700C

26" × 1.5-1.75

24" × 1.5-1.75

JOINT: PINNED

FINISH: POWDER WITH CNC ANODIZED



HLQC-04B-2

SIZE: 700C

27" × 1-3/8"

26" × 1.5-1.75

24" × 1.5-1.75

JOINT: PINNED

FINISH: POWDER WITH CNC ANODIZED

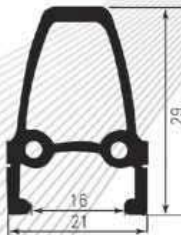

HJHT®



ALLOY DOUBLE WALL RIM



HLQC-04C-3

SIZE: 26" x 1,75
24" x 1,75
700C

JOINT: PINNED
FINISH: POWDER WITH CNC



HLQC-04C-4

SIZE: 26" x 1,5-1,75
700C

JOINT: PINNED
FINISH: POWDER WITH CNC
ANODIZCD WITH CNC



HLQM-05

SIZE: 26" x 1,75-2,125
24" x 1,75-2,125
20" x 1,75-2,125

JOINT: PINNED
FINISH: FINISH, POWDER WITH CNC
ANODIZED



HLQM-05B

SIZE: 26" x 1,75-2,125
24" x 1,75-2,125
20" x 1,75-2,125

JOINT: PINNED
FINISH: POWDER WITH CNC
ANODIZCD



HLQC-06

DESCRIPTION: PIN JOINT DOUBLE WALL
ALLOY RIM
24H/28H/32H/36H
OPTIONAL CNC
559 x 15

SIZE: 24"-700C
FINISH: ANOD COLORING
ANOD SHINY SILVER



HLQC-06A

DESCRIPTION: PIN JOINT DOUBLE WALL
ALLOY RIM
24H/28H/32H/36H
OPTIONAL CNC
559 x 13

SIZE: 24"-700C
FINISH: ANOD COLORING
ANOD SHINY SILVER



ALLOY DOUBLE WALL RIM



HLQC-07X-1

SIZE: 26" x 1.5-1.75
24" x 1.5-1.75
20" x 1.5-1.75
16" x 1.5-1.75
700C

JOINT: PINNED
FINISH: POWDER WITH CNC ANODIZED



HLQC-08A

DESCRIPTION: PIN JOINT DOUBLE WALL
ALLOY RIM
24H/28H/32H/36H
OPTIONAL STAINLESS EYELETS OR CNC
559 x 18, 500G

SIZE: 24"-700C
FINISH: ANOD COLORING
ANOD SHINY SILVER



HLQM-09A

DESCRIPTION: PIN JOINT DOUBLE WALL
ALLOY RIM
24H/28H/32H/36H
OPTIONAL STAINLESS EYELETS OR CNC
559 x 18, 500G

SIZE: 24"-700C
FINISH: ANOD COLORING
ANOD SHINY SILVER



HLQC-10A-1

SIZE: 26" x 1.75
24" x 1.75

JOINT: PINNED
FINISH: POWDER WITH CNC
ANODIZED



HLQC-16A

DESCRIPTION: PIN JOINT DOUBLE WALL
ALLOY RIM
24H/28H/32H/36H
OPTIONAL CNC
559 x 14, 420G

SIZE: 20"-700C
FINISH: ANOD COLORING
ANOD SHINY SILVER



HLQM-17A

DESCRIPTION: PIN JOINT DOUBLE WALL
ALLOY RIM
24H/28H/32H/36H
OPTIONAL CNC
559 x 14, 470G

SIZE: 24"-700C
FINISH: ANOD COLORING
ANOD SHINY SILVER

HJHT



ALLOY DOUBLE WALL RIM



HLQC-19A

DESCRIPTION: PIN JOINT DOUBLE WALL ALLOY RIM
24H/28H/32H/36H
OPTIONAL STAINLESS EYELETS W/O CNC
559 x 20, 550G

SIZE: 20" - 700C

FINISH: ANOD COLORING
ANOD SHINY SILVER



HLQC-21A

DESCRIPTION: PIN JOINT DOUBLE WALL ALLOY RIM
24H/28H/32H/36H
OPTIONAL STAINLESS EYELETS W/O CNC
559 x 20, 560G

SIZE: 20" - 700C

FINISH: ANOD COLORING
ANOD SHINY SILVER



HLQC-38B

SIZE: 24" x 1,5 - 2,125
20" x 1,5 - 2,125

JOINT: PINNED

FINISH: POWDER WITH CNC
ANODIZED



HLQC-50

SIZE: 700C



JOINT: PINNED

FINISH: POWDER W/O CNC
ANODIZED W/O CNC

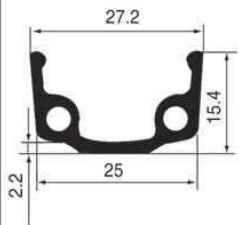
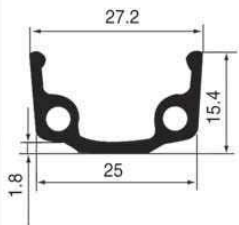
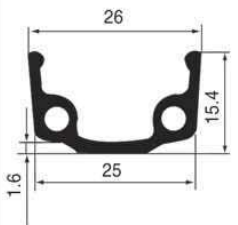
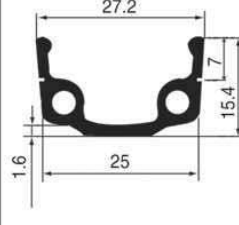
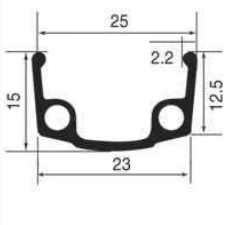
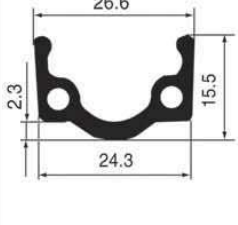
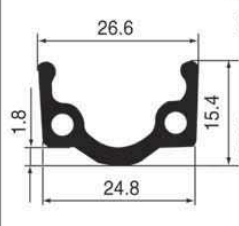
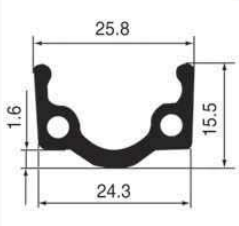
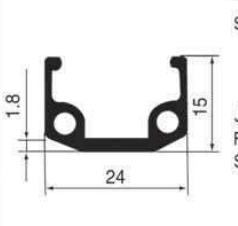
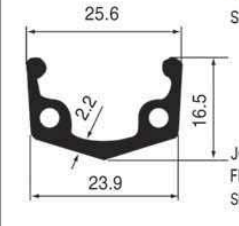
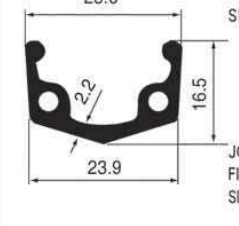
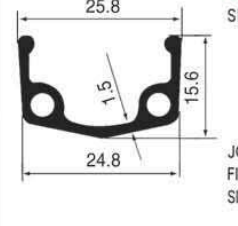
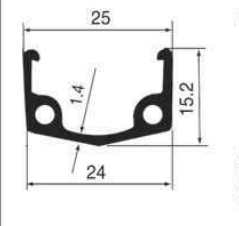
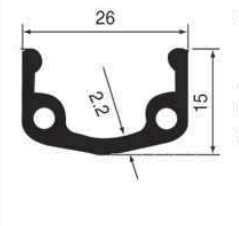
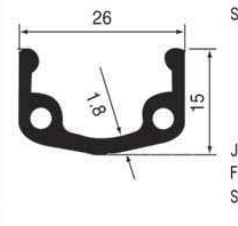
ALLOY RIM

 <p>HLQ-07 SIZE: 27" x 1-3/8 26" x 1-3/8 JOINT: PINNED FINISH: SILVER/MILL FINISH</p>	 <p>HLQ-07A SIZE: 27" x 1-3/8 26" x 1-3/8 JOINT: PINNED FINISH: SILVER/MILL FINISH</p>	 <p>HLQ-07B SIZE: 27" x 1-3/8 26" x 1-3/8 JOINT: PINNED FINISH: SILVER/MILL FINISH</p>
 <p>HLQ-07B-1 SIZE: 26" x 1-3/8 24" x 1-3/8 26" x 1.5-1.95 24" x 1.5-1.95 20" x 1.5-1.95 14" x 1.5-1.95 12" x 1.5-1.95 JOINT: PINNED FINISH: SILVER/MILL FINISH</p>	 <p>HLQ-07C SIZE: 26" x 1-3/8 24" x 1-3/8 20" x 1.5-1.75 16" x 1.5-1.75 14" x 1.5-1.75 12" x 1.5-1.75 JOINT: PINNED FINISH: SILVER/MILL FINISH</p>	 <p>HLQ-08 SIZE: 27" x 1-3/8 26" x 1-3/8 20" x 1.5-1.95 JOINT: PINNED FINISH: SILVER/MILL FINISH</p>
 <p>HLQ-08A SIZE: 26" x 1-3/8 24" x 1-3/8 20" x 1.5-1.75 16" x 1.5-1.75 JOINT: PINNED FINISH: SILVER/MILL FINISH</p>	 <p>HLQ-08B SIZE: 26" x 1-3/8 24" x 1-3/8 20" x 1.5-1.75 16" x 1.5-1.75 14" x 1.5-1.75 12" x 1.5-1.75 JOINT: PINNED FINISH: SILVER/MILL FINISH</p>	 <p>HLQ-09 SIZE: 26" x 1.5-1.75 24" x 1.5-1.75 20" x 1.5-1.75 16" x 1.5-1.75 JOINT: PINNED FINISH: SILVER/MILL FINISH</p>
 <p>HLQ-10 SIZE: 26" x 1-3/8 24" x 1-3/8 26" x 1.5 24" x 1.5 20" x 1.5 16" x 1.5 JOINT: PINNED FINISH: SILVER/SILVER/MILL FINISH</p>	 <p>HLQ-10A SIZE: 26" x 1-3/8 24" x 1-3/8 26" x 1.5 24" x 1.5 20" x 1.5 16" x 1.5 JOINT: PINNED FINISH: SILVER/SILVER/MILL FINISH</p>	 <p>HLQ-10B SIZE: 26" x 1-3/8 24" x 1-3/8 26" x 1.5 24" x 1.5 20" x 1.5 16" x 1.5 JOINT: PINNED FINISH: SILVER/SILVER/MILL FINISH</p>
 <p>HLQ-10C SIZE: 26" x 1-3/8 24" x 1-3/8 20" x 1.5-1.75 16" x 1.5-1.75 14" x 1.5-1.75 12" x 1.5-1.75 JOINT: PINNED FINISH: SILVER/MILL FINISH</p>	 <p>HLQ-11 SIZE: 27" x 1-3/8 26" x 1-3/8 24" x 1-3/8 JOINT: PINNED FINISH: SILVER/MILL FINISH</p>	 <p>HLQ-11A SIZE: 26" x 1-3/8 24" x 1-3/8 26" x 1.5 24" x 1.5 20" x 1.5 16" x 1.5 JOINT: PINNED FINISH: SILVER/SILVER/MILL FINISH</p>

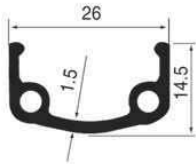
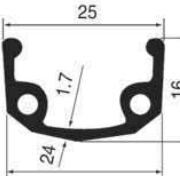
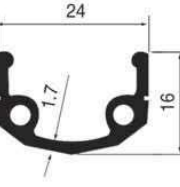
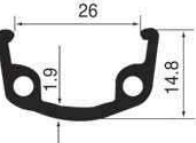
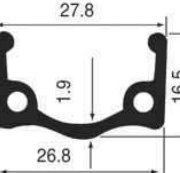
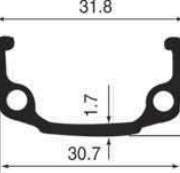
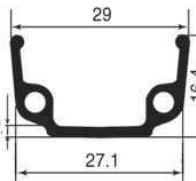
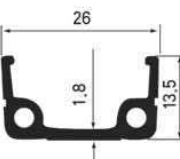
ALLOY RIM

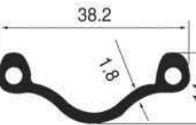
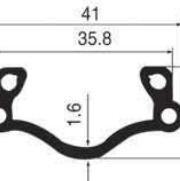
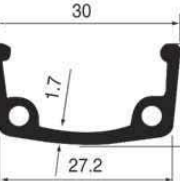
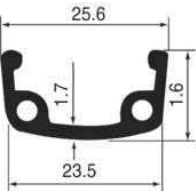
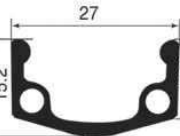
 <p>HLQ-11AD SIZE; 26" x 1-3/8 24" x 1-3/8 26" x 1.5-1.75 24" x 1.5-1.75 18" x 1.5 JOINT; PINNED FINISH; SILVER/MILL FINISH</p>	 <p>HLQ-12 SIZE; 26" x 1.5-1.75 24" x 1.5-1.75 JOINT; PINNED FINISH; SILVER/MILL FINISH</p>	 <p>HLQ-12A SIZE; 26" x 1.5-1.75 24" x 1.5-1.75 JOINT; PINNED FINISH; POWDER WITH CNC</p>
 <p>HLQ-13 SIZE; 26" x 1.5-1.75 24" x 1.5-1.75 JOINT; PINNED FINISH; SILVER/MILL FINISH</p>	 <p>HLQ-14 SIZE; 27" x 1-3/8 28" x 1.5-1.75 JOINT; PINNED FINISH; SILVER/MILL FINISH</p>	 <p>HLQ-15 SIZE; 24" x 1.5-1.75 20" x 1.5-1.75 JOINT; PINNED FINISH; SILVER/MILL FINISH</p>
 <p>HLQ-15-2 SIZE; 26" x 1-3/8 24" x 1-3/8 20" x 1.5-1.75 16" x 1.5-1.75 JOINT; PINNED FINISH; SILVER/MILL FINISH</p>	 <p>HLQ-16 SIZE; 26" x 1.5-1.75 24" x 1.5-1.75 20" x 1.5-1.75 JOINT; PINNED FINISH; SILVER/MILL FINISH</p>	 <p>HLQ-16ED SIZE; 26" x 1-3/8 24" x 1-3/8 20" x 1.5-1.75 16" x 1.5-1.75 JOINT; PINNED FINISH; SILVER/MILL FINISH</p>
 <p>HLQ-17 SIZE; 26" x 1.5-1.75 24" x 1.5-1.75 JOINT; PINNED FINISH; SILVER/MILL FINISH</p>	 <p>HLQ-18 SIZE; 26" x 1.5-1.75 24" x 1.5-1.75 JOINT; PINNED FINISH; SILVER/MILL FINISH</p>	 <p>HLQ-20 SIZE; 24" x 1.5-1.75 20" x 1.5-1.75 JOINT; PINNED FINISH; SILVER/MILL FINISH</p>
 <p>HLQ-21 SIZE; 26" x 1.5-1.75 24" x 1.5-1.75 JOINT; PINNED FINISH; SILVER/MILL FINISH</p>	 <p>HLQ-40A SIZE; 26" x 1.5-1.75 24" x 1.5-1.75 JOINT; PINNED FINISH; SILVER/MILL FINISH</p>	

TANG SHAN JIN HENG TONG

BICYCLE PARTS CO., LTD.



China & Foreign

Add: The Bicycle Industrial Region of HaiBei Town Lutai Tianjin

Tel: 86-22-69359398 69356820

Fax: 86-22-69357008

HTTP: //WWW.JHTCL.COM

E-mail: INFO@HT-CL.COM